

OPTIMALLY CONVEX CONTROLLER AND MODEL REDUCTION FOR A DYNAMIC SYSTEM

P S Khuntia*, Debjani Mitra**

** Department of Electronics and Communication Engineering
Durgapur Institute of Advanced Technology and Management
Rajbandh-12, Durgapur, West Bengal, INDIA
Email: parthsarathi_k@yahoo.com*

***Department of Electronics and Communication Engineering
Indian School of Mines, Dhanbad, Jharkhand, INDIA
Email: debjani7@yahoo.com*

Abstract: This paper presents analysis and design of a family of controllers based on numerical convex optimization for an aircraft pitch control system. A design method is proposed here to solve control system design problems in which a set of multiple closed loop performance specifications are simultaneously satisfied. The transfer matrix of the system is determined through the convex combination of the transfer matrices of the plant and the controllers. The present system with optimal convex controller has been tested for stability using Kharitonov's Stability Criteria. The simulation deals here with the problem of pitch control system of a BRAVO fighter aircraft which results in higher order close loop transfer function. So the order of the higher order transfer function is reduced to minimize the complexity of the system.

Keywords: convex optimization, Kharitonov's stability, model reduction, pitch control system.

1. INTRODUCTION

Convex controller design is an approach used to solve close loop system design problems of robotics, mechatronics, high performance aircraft and flexible space structures (Teresa, *et al.*, 2006; Fu and Mills, 2005; Tillerson, *et al.*, 2002). Such problems typically require that a set of designed parameters and control gains be adjusted simultaneously so that a prescribed close loop system performance is achieved. This system design is termed as convex controller design in literature (Boyd, Barratt 1991; Barratt and Boyd 1989). The close loop transfer matrices of the systems are combined in a convex combination to form a single transfer matrix, which satisfies that

close loop performance specification. Boyd (Boyd, *et al.*, 1990) first pointed out that many commonly used performance specifications, such as overshoot, control efforts, robust stability are convex with respect to the close loop transfer matrix. The fundamental problem of controller design for linear time invariant (LTI) systems can be solved with a restricted set of design specifications by combining recent theoretical results with numerical convex optimization techniques (Boyd and Vandenberghe, 2004). With the achievable specifications it is possible to find a controller which meets the specifications even though the controller may be complex and higher order. To get rid of the complexity of the higher order

This paper was recommended for publication by Sergiu Caraman

controller the model is reduced to obtain a simpler controller using model reduction technique (Anderson, 1989). Some early ideas of model reduction were discussed by Moore (1981) and further refinements, extensions and applications have appeared in many subsequent literatures.

2. CLASSICAL SYNTHETIC OPEN-LOOP DESIGN

Classical synthetic open-loop design methods are extremely widely applied and are described in many current introductory control texts. The classical feedback control is shown in Fig. 1 with the plant P and a controller K . K should be designed such that the output(y) will satisfy all given closed-loop performances.

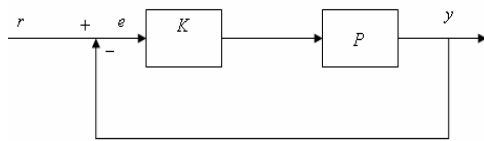

Fig.1. Classical Feedback Control

In classical open-loop methods emphasis is given on designing the loop gain, $L = PK$. The advantage of working with open loop system is that L is simply the product of P which is the fixed part of the system. The closed-loop transfer function from r to y , $PK / (1 + PK)$ depends on K in a more complicated way than open loop.

2.1. Parameter optimization methods

Decomposition of the plant inputs and outputs are shown in Fig.2.

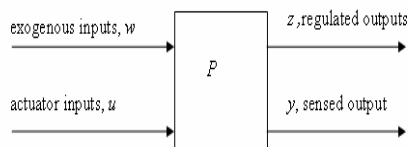

Fig.2. Decomposition of the plant inputs and outputs

The inputs to the model are divided into two vector signals. The actuator or control signal vector (u) consists of those inputs to the model that can be manipulated by the controller. Other input signals to the model will be lumped into vector signal (w) called the exogenous input. The sensor or measured signal vector (y) will consist of those output signals that are accessible to controller. The output signals from the model will be lumped into a vector signal (z) called the regulated variables.

2.2. Algebraic formulation of the decomposed plant

The plant as shown in the Fig. 2 can be described by the set of transfer functions from each of its inputs (the components of the vectors w and u) to each of its outputs (the components of z and y). The plant transfer matrix P is presented into a matrix form

$$(1) P = \begin{bmatrix} P_{zw} & P_{zu} \\ P_{yw} & P_{yu} \end{bmatrix}$$

where, P_{zw} , P_{zu} , P_{yw} and P_{yu} represents the transfer matrix from w to z ., from u to z , w to y and u to y respectively. The closed-loop transfer matrix from w to z which is denoted as (Boyd, *et al.*, 1990)

$$(2) H = P_{zw} + P_{zu}(1 - P_{yu}K)^{-1}P_{yw}$$

where K is the controller transfer matrix.

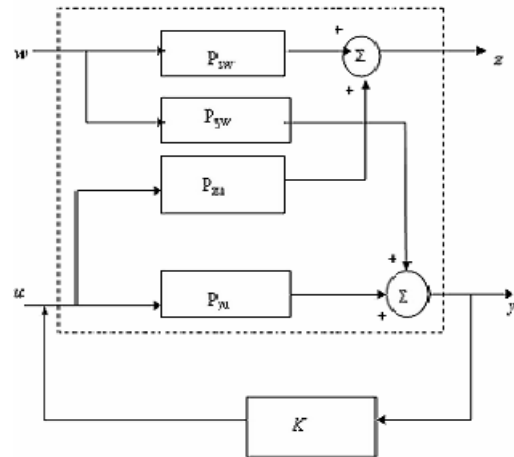

Fig.3. Decomposition of Plant

The close loop matrix H from w to z is obtained from equation 2 is

$$(3) H = \begin{bmatrix} P_{zw} & P_{zu} \\ P_{yw} & P_{yu} \end{bmatrix} = \begin{bmatrix} P_0/(1-P_0K) & P_0K/(1-P_0K) \\ P_0K/(1-P_0K) & K/(1-P_0K) \end{bmatrix}$$

3. DESIGN OF CLOSED-LOOP CONVEX CONTROLLERS

Let K and \bar{K} are two controllers each stabilizes P and yield closed-loop transfer matrices H and \bar{H} respectively, then for each $\lambda \in \mathbb{R}$ there is some controller K_λ that stabilizes P and yields closed-loop transfer matrix as (Boyd. *et al.* 1990)

$$K_\lambda = (A + \lambda B)^{-1}(C + D)$$

where

$$(4) \begin{aligned} A &= I + \bar{K}(I - P_{yu} \bar{K})^{-1} P_{yu} \\ B &= K(I - P_{yu} K)^{-1} P_{yu} - \bar{K}(I - P_{yu} \bar{K})^{-1} P_{yu} \\ C &= \bar{K}(I - P_{yu} \bar{K})^{-1} \\ D &= K(I - P_{yu} K)^{-1} - \bar{K}(I - P_{yu} \bar{K})^{-1} \end{aligned}$$

Here λ is defined as the coefficient of affine criterion of convexity. An infinite number of such stabilizing controllers may be obtained by varying a single parameter λ between 0 and 1. Out of these infinite combinations, to select the optimal convex controller we impose certain design specifications are imposed.

4. 4. DESIGN OF CONVEX CONTROLLER FOR AN ARBITRARY PLANT

The unity feed back control system with P_0 as plant TF and K as controller TF is shown in Fig. 4 below. Here 'w' is the input, 'z₁' and 'z₂' are outputs of the system.

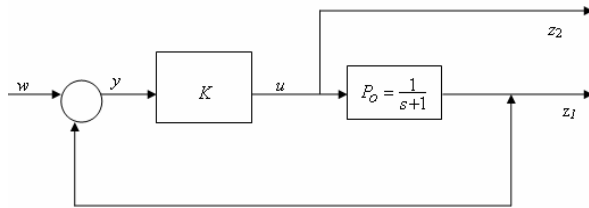

Fig.4. Block Diagram of the Control System

Let $P_0(s)$ be an arbitrary first order plant denoted as, $P_0(s) = \frac{1}{s+1}$.

Let $K(s)$ and $\hat{K}(s)$ are two arbitrary PI (Proportional Integral) controllers which stabilizes the plant P_o

$$K(s) = 3.0 + \frac{2.0}{s}, \quad \hat{K}(s) = 2 + \frac{40}{s}$$

The transfer matrix from 'w' to 'z₁' with K , $H_1(s) = \frac{P_0(s)K(s)}{1 + P_0(s)K(s)} = \frac{s+2}{s^2+2s+2}$

The transfer matrix from 'w' to 'z₂', with K , $H_2(s) = \frac{K(s)}{1 + P(s)K(s)} = \frac{s^2+3s+2}{s^2+2s+2}$

Now the total transfer matrix $H(s)$ can be shown below as

$$(5) H(s) = \begin{bmatrix} H_1(s) \\ H_2(s) \end{bmatrix} = \begin{bmatrix} \frac{s+2}{s^2+2s+2} \\ \frac{s^2+3s+2}{s^2+2s+2} \end{bmatrix}$$

The transfer matrix from 'w' to 'z₁' with \hat{K} , $\hat{H}_1(s) = \frac{P_0 \hat{K}}{1 + P_0 \hat{K}} = \frac{2s+10}{s^2+3s+10}$

The transfer matrix from 'w' to 'z₂', with \hat{K} , $\hat{H}_2(s) = \frac{K}{1 + PK} = \frac{2s^2+12s+10}{s^2+3s+10}$

Now the total transfer matrix $\hat{H}(s)$ is shown below as

$$(6) \hat{H}(s) = \begin{bmatrix} \hat{H}_1(s) \\ \hat{H}_2(s) \end{bmatrix} = \begin{bmatrix} \frac{2s+10}{s^2+3s+10} \\ \frac{2s^2+12s+10}{s^2+3s+10} \end{bmatrix}$$

The step responses $z_1 w(t)$ and $z_2 w(t)$ with controllers K and \hat{K} respectively are plotted in the fig. 5 and fig. 6 below show that both the outputs z_1 and z_2 are stable with above said controllers. The solid line shows the response with controller K and dotted line with \hat{K} .

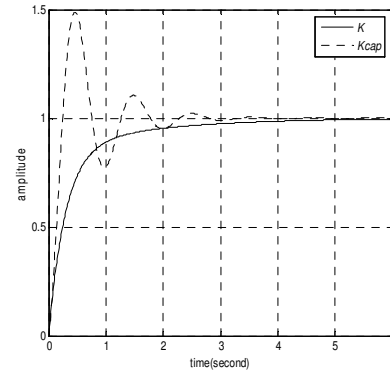

Fig.5. Step Response of $z_1 w(t)$ with K and \hat{K} .

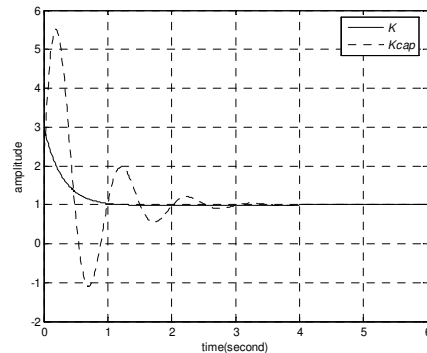

Fig.6. Step Response of $z_2 w(t)$ with K and \hat{K} .

Now the close loop transfer matrix with introduction of optimizing parameter λ can be expressed as the linear combination of $H(s)$ and $\hat{H}(s)$ as below

$$(7) H_{\lambda}(s) = \lambda H(s) + (1-\lambda)\hat{H}(s)$$

$$(8) H_{\lambda}(s) = \lambda \begin{bmatrix} \frac{s+2}{s^2+2s+2} \\ \frac{s^2+3s+2}{s^2+2s+2} \end{bmatrix} + (1-\lambda) \begin{bmatrix} \frac{2s+10}{s^2+3s+10} \\ \frac{2s^2+12s+10}{s^2+3s+10} \end{bmatrix}$$

The values of the parameter λ taken here are $[-0.3, 0, 0.5, 1.0, 1.3]$. The optimum value of λ is selected where Mean Square value of Error (MSE) is minimum. The MSE is found out by calculating the norm of the error for each value of the λ . The optimum value found here is 0.5. The closed loop performance from w to z_1 generated by K and \hat{K} is plotted for five members of the one parameter family λ in fig. 7 below. The corresponding response from w to z_2 is plotted in Fig. 8 shown below

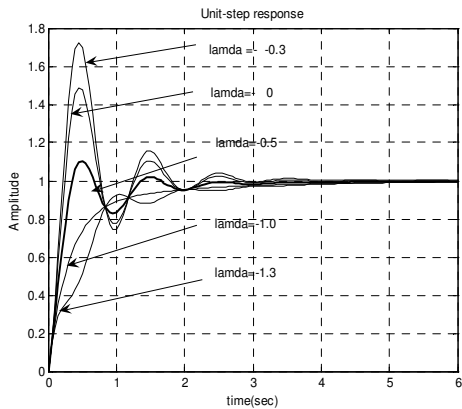

Fig.7. Step Response of $H_{\lambda}(s)$ from 'w' to 'z₁' for various values of λ

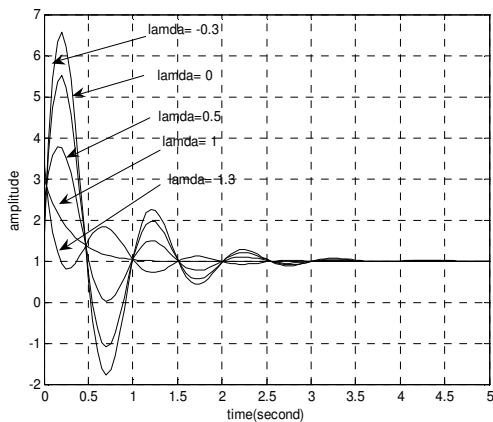

Fig.8. Step Response of $H_{\lambda}(s)$ from 'w' to 'z₂' for various values of λ

Then the transfer matrix for optimum value of $\lambda = 0.5$ is obtained from equation 8

$$(9) H_{0.5}(s) = \begin{bmatrix} \frac{2.5s^3 + 29.5s^2 + 145s + 80}{s^4 + 7s^3 + 54s^2 + 166s + 80} \\ \frac{2.5s^4 + 32s^3 + 174.5s^2 + 225s + 80}{s^4 + 7s^3 + 54s^2 + 166s + 80} \end{bmatrix}$$

The close loop Transfer matrix, H of the control system shown in figure 4 is,

$$(10) H = \frac{P_0}{1 + P_0K}$$

The optimum controller transfer function $K_{0.5}(s)$ is now obtained from equation 9 and equation.10.

$$(11) K_{0.5}(s) = \frac{2.5s^3 + 29.5s^2 + 145s + 80}{s^3 + 3.5s^2 + 21s}$$

It is found in equation 11 that the value of $K_{0.5}(s)$ is neither a PI controller nor the average of two PI controllers though it is obtained from K and \hat{K} . Rather it is a modified optimum controller which stabilizes the close loop performance.

5. DESIGN OF CONVEX PITCH CONTROLLER

The purpose of this example is to design a convex controller for a pitch control system of BRAVO fighter aircraft shown in Fig. 9 to obtain a regulated pitch angle θ with following performance criteria: Steady state error ≤ 0.001 , Phase margin $\geq 45^\circ$ and Gain margin ≥ 3 dB

As shown in the Fig. 9 below θ_{ref} is the reference pitch angle, δ_E is the elevator deflection angle and θ is actual pitch angle of the aircraft

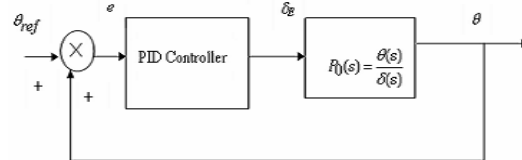

Fig.9. Block Diagram of Pitch Control System

The plant $P_0(s) = \frac{\theta(s)}{\delta_E(s)}$ is the transfer function obtained from flight condition-3 (Maclean, 1990).

$$(12) P_0(s) = \frac{(20.67s + 12.84)}{s^3 + 1.822s^2 + 28.54s}$$

Let the controller K and \hat{K} be two PID (Proportional-Integral-Derivative) controllers which stabilize the plant $P_0(s)$.

General Form of the transfer function of a PID controller is expressed as follows

$$(13) \quad g_c(t) = K_p e(t) + K_I \int_0^t e(t) dt + K_d \frac{de(t)}{dt}$$

$$Gc(s) = [K_p + \frac{K_I}{s} + K_d s]$$

where K_p, K_I and K_d are Proportional, Integral and Derivative gains.

The PID controllers, $K(s)$ and $\hat{K}(s)$ which stabilizes the plant are found out as

$$(14) \quad K(s) = [1.36 + \frac{2.312}{s} + 0.2s],$$

$$\hat{K}(s) = [2.52 + \frac{7.938}{s} + 0.2s]$$

The close loop transfer functions with $K(s)$ and $\hat{K}(s)$, i.e. are $H(s)$ and $\hat{H}(s)$ are denoted as

$$(15) \quad H(s) = \frac{P_0(s)K(s)}{1 + P_0(s)K(s)}, \quad \hat{H}(s) = \frac{P_0(s)\hat{K}(s)}{1 + P_0(s)\hat{K}(s)}$$

From equation 15, $H(s)$ is obtained as

$$(16) \quad H(s) = \frac{4.134s^3 + 30.68s^2 + 65.25s + 29.69}{s^4 + 5.956s^3 + 59.22s^2 + 65.25s + 29.69}$$

Similarly from equation 16 $\hat{H}(s)$ is obtained as,

$$(17) \quad \frac{4.134s^3 + 54.76s^2 + 196.5s + 101.9}{s^4 + 5.956s^3 + 83.3s^2 + 196.5s + 101.9}$$

The step responses of $H(s)$ and $\hat{H}(s)$ are plotted below in the fig. 10 show that the output $\theta(t)$ is stable with controllers K and \hat{K} . The solid line shows the response with controller K and dotted line with \hat{K} .

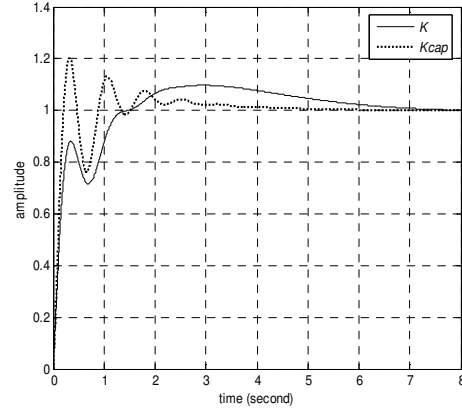

Fig.10. Step Response with controllers K and \hat{K}

With introduction of optimizing parameter λ , $H_\lambda(s)$ is expressed as the linear combination of $H(s)$ and $\hat{H}(s)$ as shown below

$$(18) \quad H_\lambda(s) = \lambda H(s) + (1-\lambda)\hat{H}(s)$$

$$H_\lambda(s) = \lambda \left[\frac{4.134s^3 + 30.68s^2 + 65.25s + 29.69}{s^4 + 5.956s^3 + 59.22s^2 + 65.25s + 29.69} \right] +$$

$$(1-\lambda) \left[\frac{4.134s^3 + 54.76s^2 + 196.5s + 101.9}{s^4 + 5.956s^3 + 83.3s^2 + 196.5s + 101.9} \right]$$

The values of λ taken here are $[-0.5, -0.3, 0.25, 1.0, 1.5]$. The optimum value of λ is selected where MSE minimum. MSE is found out as done in the previous example and the values are listed in the tabular form for respective value λ given below.

λ	-0.5	-0.3	0.25	1.0	1.5
MSE	0.0102	0.0098	0.0096	0.0114	0.0135

For $\lambda = 0.25$ MSE is minimum. So $\lambda = 0.25$ is considered as the optimum value of λ (λ_{opt}).

Substituting the λ_{opt} in equation 18 the optimum close loop transfer function $H_{0.25}(s)$ is found out.

$$(19) \quad \frac{4.134s^7 + 73.36s^6 + 723.7s^5 + 4535s^4 + 14970s^3 + 19970s^2 + 12480s + 3026}{s^8 + 11.91s^7 + 178s^6 + 1111s^5 + 6624s^4 + 17860s^3 + 21330s^2 + 12480s + 3026}$$

The step response of equation 19 is plotted for five different values of λ and shown in Fig. 11 below

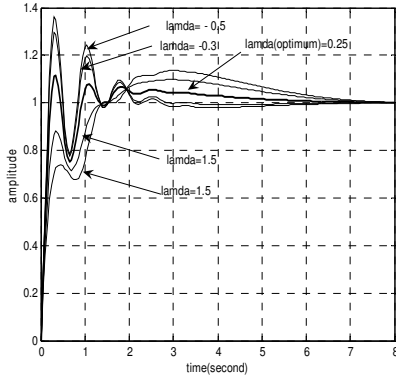

Fig.11. Step Response of the Pitch Controller for various values of λ

From equation 21 the convex controller K is found out at $\lambda = 0.25$, $K_{0.25}(s)$ as follows.

$$(20) K_{0.25}(s) = \frac{0.2s^6 + 3.425s^5 + 32.88s^4 + 199s^3 + 6006s^2 + 5929s + 235.6}{s^5 + 5956s^4 + 65.24s^3 + 98.06s^2 + 47.75s - 4.305e-012}$$

From equation 19 the convex controller $K_{0.25}(s)$ is found out at $\lambda = 0.25$ as follows.

$$(20) K_{0.25}(s) = \frac{0.2s^6 + 3.425s^5 + 32.88s^4 + 199s^3 + 6006s^2 + 5929s + 235.6}{s^5 + 5956s^4 + 65.24s^3 + 98.06s^2 + 47.75s - 4.305e-012}$$

It is observed that $K_{0.25}(s)$ is neither a PID controller nor the average of two PID controllers. Rather it is a optimized controller which stabilizes the close loop performance. The Bode plot for equation 20 is plotted in the fig. 12 below to find out gain margin (GM) and phase margin (PM) to measure the performance criteria. It was found from the phase plot, the GM is very high as the phase plot does not cross the -180° line and the minimum PM obtained is 84.5° which is higher than the required PM. The steady state value to the step input is found out to be 1 resulting steady state error zero. Thus the convex controller satisfies all the performance criteria.

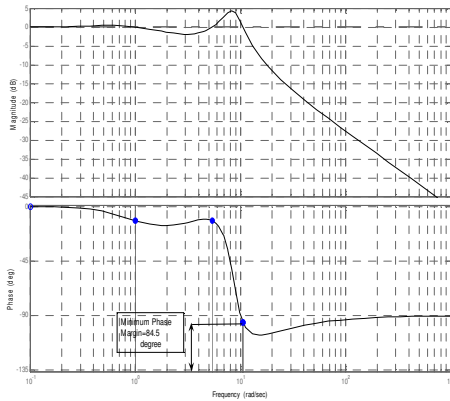

Fig.12. The Bode Plot of $H_{0.5}(s)$

6. KHATITONOV'S STABILITY TEST

Kharitonov's stability (Kharitonov, 1979; Minnichelli, *et.al.*, 1989) test is carried out to show the obtained close loop transfer function $H_{\lambda=0.25}(s)$ is stable with respect to parametric perturbation.

The characteristic equation for close loop pitch control system with optimal controller is obtained from equation 19 is given below

$$(21) s^8 + 12s^7 + 178s^6 + 1111s^5 + 6624s^4 + 17856s^3 + 21331s^2 + 12484s + 3026 = 0$$

The four polynomial $g_1(s)$, $g_2(s)$, $h_1(s)$, and $h_2(s)$ with 20% perturbation to the coefficients of the above characteristic equation are found below.

$$(22) \begin{cases} g_1(s) = 2723.4 + 23464.1s^2 + 5961.6s^4 + 195.8s^6 + s^8 \\ h_1(s) = 11235.6s + 19641.6s^3 + 999.9s^5 + 13.2s^7 \\ g_2(s) = 3328.6 + 19197.9s^2 + 7286.4s^4 + 160.2s^6 + s^8 \\ h_2(s) = 13732.4s + 16070.4s^3 + 1222.1s^5 + 10.8s^7 \end{cases}$$

The four Kharitonov's polynomial

$$(23) k_{kl} = g_k(s) + h_l(s) \text{ for } k, l = 1, 2$$

The Kharitonov's polynomial are computed using equation 22 and 23 found to be Hurwitz. So the pitch control system is stable within a specified value of parametric perturbation.

$$(24) \begin{cases} k_{11}(s) = 2723.4 + 11235.6s + 23464.1s^2 + 19641.6s^3 + 5961.6s^4 + 999.9s^5 + 195.8s^6 + 13.2s^7 + s^8 \\ k_{12}(s) = 2723.4 + 13732.4s + 23464.1s^2 + 16070.4s^3 + 5961.6s^4 + 1222.1s^5 + 195.8s^6 + 10.8s^7 + s^8 \\ k_{22}(s) = 3328.6 + 13732.4s + 19197.9s^2 + 16070.4s^3 + 7286.4s^4 + 1222.1s^5 + 160.2s^6 + 10.8s^7 + s^8 \\ k_{21}(s) = 3328.6 + 11235.6s + 19197.9s^2 + 19641.6s^3 + 7286.4s^4 + 999.9s^5 + 160.2s^6 + 13.2s^7 + s^8 \end{cases}$$

7. MODEL REDUCTION

The algorithm (Matlab ; Levit and Sreeram, 1995) proposed in this paper for model reduction computes state-space balancing transformations directly from a state-space realization avoiding unnecessary matrix products. A key feature of this algorithm is the determination of a transformation through computing

the singular value decomposition (SVD) of a certain product of matrices without explicitly forming the product. The model reduction is performed after preserving all closed-loop stability and the closed-loop performances.

$H_{0.25}(s)$ in equation 19 is converted to a continuous state-space model and grammians (Matlab) denoted as g are found as follows

$$g = [0.8846, 0.5282, 0.1723, 0.0866, 0.00119, 0.0071, 0.0031, 0.0001]$$

The last three values of g are eliminated to obtain 5th order reduced model .

Transfer function of reduced order model using *hdel* (Matlab) method results as

$$(25) H_{0.25}(s) = \frac{4.144s^4 + 64.08s^3 + 375s^2 + 584.6s + 356}{s^5 + 9.808s^4 + 102.6s^3 + 484.9s^2 + 602.1s + 353.2}$$

Transfer function of reduced order model using *hmdc* (Matlab) method results as

$$(26) H_{0.25}(s) = \frac{-0.008177s^5 + 4.542s^4 + 134s^3 + 1353s^2 + 3199s + 1354}{s^5 + 28.59s^4 + 207.6s^3 + 2000s^2 + 3195s + 1354}$$

The fig. 13 below illustrates the comparison between the step responses of the original model as in equation 19 and the reduced models obtained in equations 25 and 26 using both model reduction techniques discussed above.

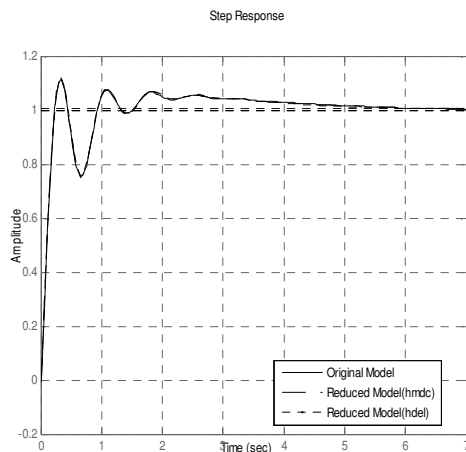

Fig.13. Step Response of the Original Model and Reduced Model

8. CONCLUSION

This makes a sensible formulation of the controller design problem by considering simultaneously all the closed-loop transfer functions of interest. The

paper stresses that the closed-loop transfer matrix H should include every closed loop transfer function necessary to evaluate a candidate controller. Most of the design specifications for pitch control of an aircraft are closed loop convex. There might be infinite number of stable controllers for any real value of the λ in the range 0 to 1. But for a optimum value of λ there exists a single controller which satisfies all close loop performance criteria. The overshoot and the settling time of a pitch maneuvering dynamics would be brought down to an appreciable limit by a properly designing a convex controller. Mean Square Error (MSE) method of optimizing the parameter λ to produce optimal performance specification in all possible combination of pitch dynamics has been suggested. The combined system with plant and convex controller is stable for parametric perturbation and it satisfies all design specifications. The order of the plant is reduced to obtain a relatively lesser degree of transfer function which yields a simpler controller.

9. REFERENCES

- Anderson, B. D. O. and Y. Liu, (1989). Controller Reduction: Concepts and Approach, *IEEE Transaction on Automatic Control*, **Volume 34**, No. 8, pp. 802-812.
- Barratt, C. H. and S. P. Boyd (1989). Examples of Exact Trade offs in Linear Controller Design, *IEEE Control System Magazine*, pp. 46-52.
- Boyd S., Craig Barratt and Stephen, Norman (1990). Linear Controller Design: Limits of Performance via Convex Optimization, Proceedings of IEEE, **Volume 78**, No. 3.
- Boyd, S. and L. Vandenberghe (2004). *Convex Optimization*, Cambridge Press.
- Boyd, S. P. and C. H. Barratt (1991). *Linear Controller Design: Limits of Performance*, Prentice Hall, Englewood Cliffs, NJ.
- Fu, K. and J. K Mills (2005). A Convex Approach Solving Simultaneous Mechanical Structure and Control System Design Problems with Multiple Closed loop Performance Specifications, *Journal of Dynamic Systems measurement and Control*, **Volume 127**, pp. 57-68.
- Kharitonov, V.L. (1979). Asymptotic Position of a Family of System of Linear Differential Equations, *Differential Equations*, **Volume 14**, pp. 1483-1485.

- Levit C. and V. Sreeram (1995). Model Reduction via Parameter Matching using a Gramian Technique, *Control Theory and Applications*, *IEE Proceedings*, **Volume 142**, Issue 3, pp.186- 196.
- Maclean, D. (1990). Automatic Flight Control Systems, PHI (UK) Ltd.
- MATLAB Control System Toolbox.*
- Michael, T., G. Inalhan, J. P. How (2002). Co-ordination and control of distributed spacecraft systems using convex optimization techniques, *International Journal of Robust and Nonlinear Control*, pp. 207–242.
- Miller, T. G., W. B. Timothy and S. Rock (2006). Control of A Climbing Robot Using Real-Time Convex Optimization, *Proceedings of the IFAC Symposium on Mechatronic Systems*. **Volume 4** (Part 1).
- Minnichelli, R. J., J. J. Anagnost, and C.A. Desoer (1989). An Elementary Proof of Kharitonov's Stability Theorem with Extensions, *IEEE Trans. Automatatic Control.*, Volume **34**, pp. 995–998.
- Moore, B. C. (1981). Principal Component Analysis in Linear Systems: Controllability, Observability, and Model Reduction, *IEEE Trans. Automat. Control.*, **Volume 26**, pp.17-32.

AUTHORS

P S Khuntia



Presently Assistant Professor in Electronics and Communication Engineering Department of Durgapur Institute of Advanced Technology and Management, Durgapur, India. His research interests include control, Intelligent Control and Soft Computing.

Debjani Mitra



Presently Associate Professor in Electronics and Instrumentation Department of Indian School of Mines, Dhanbad, India. Her research interests include Communication Systems, Network Security, Information Fusion and Soft Computing.